

1983 DATSUN 280ZX MAIN HARNESS (TURBO)

NO.	FROM	TO	REMARKS
100	ENGINE ELECTRICAL SYSTEM		
100	ENG ROOM H	F/LINK	
101	100	F/BLOCK	
102	566	ACC RELAY	
103	566	IGN RELAY	
104	F/BLOCK	ACC RELAY	
105	F/BLOCK	IGN RELAY	
107	IGN SW	F/BLOCK	
108	143	IGN RELAY	
110	F/LINK	IGN SW	
111	IGN SW	IGN COIL	
114	107	ACC RELAY	
116	101	F/BLOCK	
120	IGN SW	ENG ROOM H	
140	IGN SW	FUEL PUMP RELAY	
141	110	EG1 H	
142	120	ENG ROOM H	
143	111	FUEL PUMP SUB H	
144	144	EG1 H	
146	EG1 H	FUEL PUMP RELAY	
148	145	EG1 H	
151	INST H	EG1 H	
152	INST H	EG1 H	
153	ENG ROOM H	EG1 H	
156	EG1 H	FUEL PUMP SUB H	
157	FUEL PUMP SUB H	EG1 H	
160	F/BLOCK	ENG ROOM H	
164	ENG ROOM H	1/3	
170	440	INT BLOWER TANK	
171	300	INT BLOWER TANK	
172	ENG ROOM H	INT BLOWER TANK	
173	EG1 H	INT BLOWER TANK	
200	LIGHTING SYSTEM		
200	F/LINK	F/BLOCK	
201	F/BLOCK	COMB SW	
202	F/BLOCK	COMB SW	
203	COMB SW	ENG ROOM H	
204	COMB SW	ENG ROOM H	
206	COMB SW	ENG ROOM H	
211	204	INST H	
220	F/BLOCK	COMB SW	
221	433	INST H	
227	AIRCON H	INST H	
228	233	AIRCON H	
229	229	AIRCON H	
230	233	CONSOLE H	
231	233	CONSOLE H	
233	COMB SW	ENG ROOM H	
234	233	SIDE M LAMP LH	
237	233	SIDE M LAMP RH	
240	233	LICENSE LAMP	
242	242	TAIL & STOP L SENSOR	
243	243	RR COMB L LH	
244	233	RR COMB L RH	
250	F/BLOCK	ROOM L TIMER	
251	ROOM L	ROOM L TIMER	
252	ROOM LAMP TIMER	DIODE BOX	
253	ROOM LAMP TIMER	DIODE CONN	
254	270	DOOR SW RH	
255	270	DIODE	
256	273	STEP LAMP RH	
257	293	STEP LAMP LH	
258	290	291	
259	290	291	
260	290	291	
261	250	SHOT LAMP	
266	257	B/DOOR SW	
267	257	LUGGAGE ROOM L	
268	257	242 SEATER MODEL	
269	257	212 SEATER MODEL	
270	ROOM L TIMER	DIODE BOX/DOOR SW LH	
271	273	DOOR H LH	
272	DOOR H LH	251	
273	490	ROOM L TIMER	
274	ROOM L TIMER	DOOR H LH	
275	273	DOOR H RH	
276	280	DOOR H LH	
277	DOOR H RH	270	
278	DOOR H LH	282	
280	290	STEP L RELAY	
281	STEP L RELAY	279	
282	DOOR H RH	STEP L RELAY	
283	DOOR H LH	277	
300	METER, GAUGES AND WARNING SYSTEM		
300	F/BLOCK	INST H	
302	RESISTOR	INST H	
303	INST H	TANK UNIT GAUGE	
304	INST H	EG1 H	
307	273	INST H	
308	IGN COIL	RESISTOR	
309	INST H	TANK UNIT GAUGE	
315	DIODE BOX	253	
316	DIODE BOX	DIODE CONN	
317	DIODE BOX	DIODE	
317	DIODE CONN	260	
320	INST H	TANK UNIT GAUGE	
321	INST H	316	
322	INST H	252	
322	INST H	252	
326	334	PARKING B SW	
333	400	INST H	
334	SEAT BELT TIMER	SEAT BELT SW	
336	SEAT BELT SW	SEAT BELT SW	
340	410	INT CHIME	
341	STRG LOCK SW	STRG LOCK SW	
342	DIODE BOX	DIODE BOX	
343	233	DIODE BOX	
345	DOOR SW LH	DIODE BOX	
350	300	INT CHIME	
361	CONSOLE H	TAIL & STOP L SENSOR	
362	CONSOLE H	TAIL & STOP L SENSOR	
371	INST H	BOOST S AMP	
375	608	BOOST S AMP	
376	INST H	BOOST S AMP	
377	INST H	BOOST S AMP	
380	INST H	HOLD RELAY	
381	INST H	HOLD RELAY	
382	300	HOLD RELAY	
400	SIGNAL SYSTEM		
400	F/BLOCK	HAZARD SW	
401	HAZARD SW	HAZARD SW	
402	T/SIGNAL F/UNIT	T/SIGNAL F/UNIT	
403	COMB SW	COMB SW	
404	COMB SW	ENG ROOM H	
406	404	RR COMB L RH	
410	F/BLOCK	RR COMB L LH	
411	HAZARD SW	HAZARD SW	
412	HAZARD SW	402	
413	HAZARD SW	403	
420	405	404	
421	406	INST H	
430	F/BLOCK	INST H	
433	ENG ROOM H	FNG ROOM H	
440	F/BLOCK	COMB SW	
443	STOP SW	STOP SW	
444	TAIL & STOP L SENSOR	TAIL & STOP L SENSOR	
447	ENG ROOM H	RR COMB L LH	
448	447	RR COMB L RH	
500	ACCESSORY SYSTEM		
500	F/BLOCK	WIPER MOTOR	
501	500	INT WIPER AMP	
502	500	WIPER MOTOR	
503	F/BLOCK	B/DOOR SUB H	
504	INT WIPER AMP	WIPER MOTOR	
505	INT WIPER AMP	WIPER MOTOR	
506	COMB SW	WIPER MOTOR	
507	COMB SW	WIPER MOTOR	
508	COMB SW	INT WIPER AMP	
509	COMB SW	INT WIPER AMP	
510	COMB SW	INT WIPER AMP	
511	WASHER TANK	508	
512	501	H/LAMP CLEANER SW	
513	H/LAMP CLEANER SW	H/LAMP CLEANER	
514	WIPER MOTOR	WIPER TANK	
515	503	INST H	



REMARKS	NO.	FROM	TO	REMARKS
	516	INST H	B/DOOR SUB H	
	517	INST H	B/DOOR SUB H	
	519	COMB SW	INT WIPER AMP	
	520	F/BLCK (RI)	CONSLE H	
	521	ANTENNA RELAY	CONSLE H	
	522	CONSLE H	MOTOR ANTENNA	
	523	CONSLE H	MOTOR ANTENNA	
	525	273	CONSLE H	
	526	ANTENNA RELAY	CONSLE H	
	527	ANTENNA RELAY	300	
	528	ANTENNA RELAY	MOTOR ANTENNA	
	529	ANTENNA RELAY	290	
	534	CONSLE H	SPEAKER LH	
	535	CONSLE H	SPEAKER RH	
	536	CONSLE H	SPEAKER RH	
	537	CONSLE H	CONDENSER	
	539	111	CONSLE H	
	540	F/BLCK	CONSLE H	
	543	ANTENNA RELAY	980	
	546	390	RR DEF RELAY	
	547	RR DEF CONTROLLER	RR DEF RELAY	
	550	F/BLCK	RR DEF RELAY	
	551	F/BLCK	INST H	
	552	INST H	B/DOOR SUB H	
	553	RR DEF CONTROLLER	INST H	
	554	RR DEF CONTROLLER	INST H	
	555	57	INST H	
	556	57	INST H	
	557	RR DEF RELAY	RR DEF CONTROLLER	
	558	RR DEF CONTROLLER	B/DOOR SUB H	
	559	RR DEF CONTROLLER	B/DOOR SUB H	
	560	F/BLCK	AIRCORN H	
	561	AIRCORN H	ENG ROOM H	
	562	AIRCORN H	ENG ROOM H	
	563	60	ENG ROOM H	
	566	101	AIRCORN H	
	568	101	ENG ROOM H	
	569	AIRCORN H	EGG H	
	570	105	CIRCUIT BRAKER	
	572	CIRCUIT BRAKER	DOOR H LH	
	573	572	DOOR H LH	
	578	DOOR H LH	DOOR H RH	
	579	DOOR H LH	DOOR H RH	
	580	687	V/N UNIT	
	581	687	V/N UNIT	
	586	687	V/N UNIT	
	588	687	V/N UNIT	
	590	520	REMOCON M SW LH	
	591	598	INST H	
	592	REMOCON M SW LH	DOOR H LH	
	593	REMOCON M SW LH	DOOR H LH	
	594	REMOCON M SW LH	DOOR H LH	
	595	REMOCON M SW LH	DOOR H RH	
	596	REMOCON M SW RH	DOOR H RH	
	597	REMOCON M SW RH	DOOR H RH	
	598	R/C MIRROR SW	DOOR H RH	
	599	898	DOOR H LH	
	600	SUPPLEMENTAL NUMBER	DOOR H LH	
	606	300	K D SW	
	606	K D SW	ENG ROOM H	
	607	233	TORCON IND LAMP	
	608	227	227	
	680	400	INST H	
	681	INST H	ASCD CONTROLLER	
	682	ASCD CONTROLLER	INST H	
	683	682	INST H	
	684	ASCD RELAY	ENG ROOM H	
	686	151	ASCD CONTROLLER	
	687	COMB SW	ASCD CONTROLLER	
	688	COMB SW	ASCD CONTROLLER	
	689	COMB SW	570	
	670	CLUTCH SW	ASCD CONTROLLER	
	671	CLUTCH SW	STOP SW	
	672	681	CLUTCH SW	
	673	400	ASCD RELAY	
	674	ASCD RELAY	661	
	675	ASCD CONTROLLER	ENG ROOM H	
	676	ASCD CONTROLLER	ENG ROOM H	
	677	ASCD CONTROLLER	ENG ROOM H	
	679	ASCD CONTROLLER	983	
	680	448	ASCD CONTROLLER	

NO.	FROM	TO	REMARKS
682	COMB SW	ASCD CONTROLLER	
683	COMB SW	ASCD CONTROLLER	
685	691	DIODE CONN	
685	661	DIODE CONN	
687	DIODE CONN	688	
688	430	688	
690	430	688	
691	DOOR H RH	DOOR L TIMER	
692	DOOR H RH	DOOR L TIMER	
693	DOOR H LH	DOOR L TIMER	
694	DOOR H LH	DOOR L TIMER	
700	SUPPLEMENTAL NUMBER	DOOR L TIMER	
722	233	V/N UNIT	
725	535	V/N UNIT	
726	CONSLE H	V/N UNIT	
727	V/N UNIT	V/N UNIT	
728	V/N UNIT	V/N UNIT	
731	673	V/N UNIT	
732	780	V/N UNIT	
735	781	V/N UNIT	
736	667	V/N UNIT	
739	752	V/N UNIT	
740	753	V/N UNIT	
747	STRG LOCK SW	DOOR SW LH	
750	DIODE	DOOR SW LH	
751	DIODE	DOOR SW RH	
752	DIODE CONN	TANK UNIT GAUGE	
753	DIODE CONN	DIODE CONN	
755	INST H	DIODE CONN	
756	INST H	ENG ROOM H	
757	V/N UNIT	ENG ROOM H	
759	535	CONSLE H	
761	761	CONSLE H	
900	GROUND	GROUND	
931	INST H	ENG ROOM H	
940	CONSLE H	931	
950	DOOR L TIMER	973	
951	ROOM L TIMER	950	
952	STOP L RELAY	992	
960	BODY GROUND	931	
961	BODY GROUND	931	
962	AIRCORN H	931	
963	ASCD RELAY	965	
964	WIPER MOTOR	965	
965	COMB SW	931	
966	KEY LAMP	966	
967	T/SIGNAL F/UNIT	965	
968	INT CHIME	965	
969	INT WIPER AMP	965	
970	SEAT BELT TIMER	962	
971	DOOR H RH	931	
972	DOOR H LH	963	
973	REMOCON M SW RH	983	
975	REMOCON M SW LH	961	
976	ROOM LAMP	961	
977	977	968	
978	SPOT LAMP	961	
980	TANK UNIT GAUGE	961	
981	SIDE M LAMP RH	961	
982	RH COMB L RH	961	
983	TAIL & STOP L SENSOR	961	
984	LICENSE LAMP	532	
985	IGN RELAY	962	
986	RH COMB L LH	961	
987	SIDE M LAMP LH	961	
988	MOTOR ANTENNA	986	
989	HOLD RELAY	931	
990	ACC RELAY	962	
991	FUEL PUMP RELAY	962	
993	H/LAMP CLEANER	964	
994	INJ BLOWER TIMER	931	
995	RR DEF CONTROLLER	901	
996	V/N UNIT	901	
998	VANITY MIRROR L	901	
999	ANTENNA RELAY	960	

REMARKS

VOICE WARNING
VOICE WARNING
VOICE WARNING

VOICE WARNING

VOICE WARNING
VOICE WARNING
VOICE WARNING
VOICE WARNING
VOICE WARNING
VOICE WARNING
VOICE WARNING
VOICE WARNING
VOICE WARNING
VOICE WARNING

VOICE WARNING
VOICE WARNING
VOICE WARNING
VOICE WARNING

VOICE WARNING

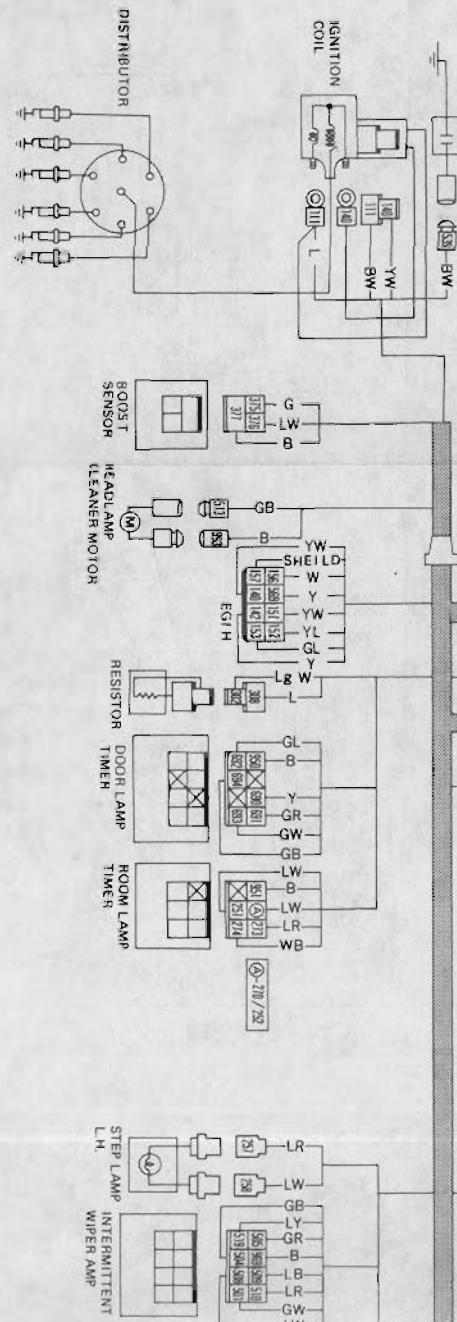
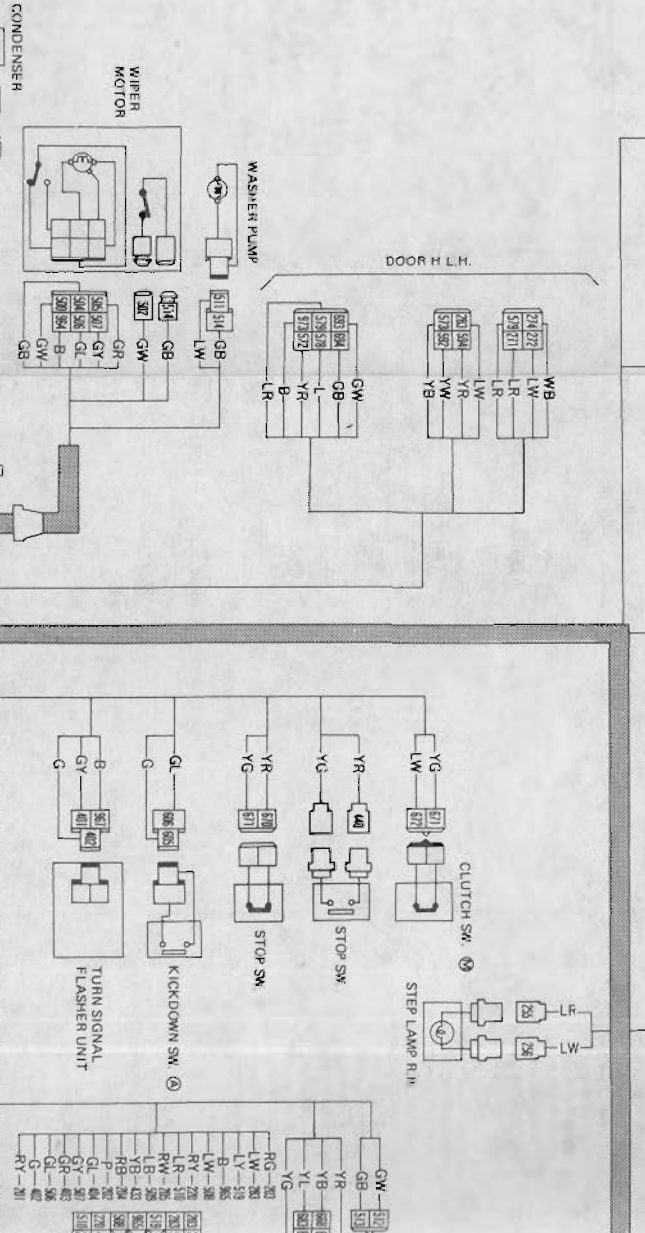
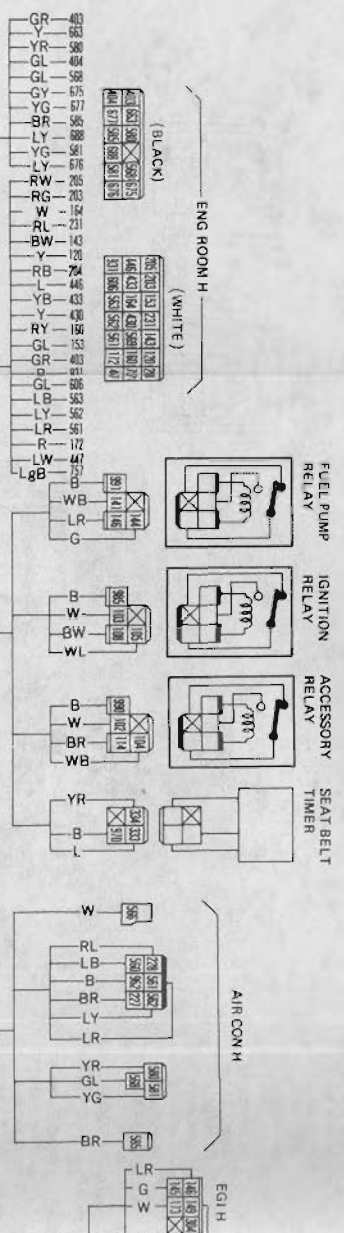

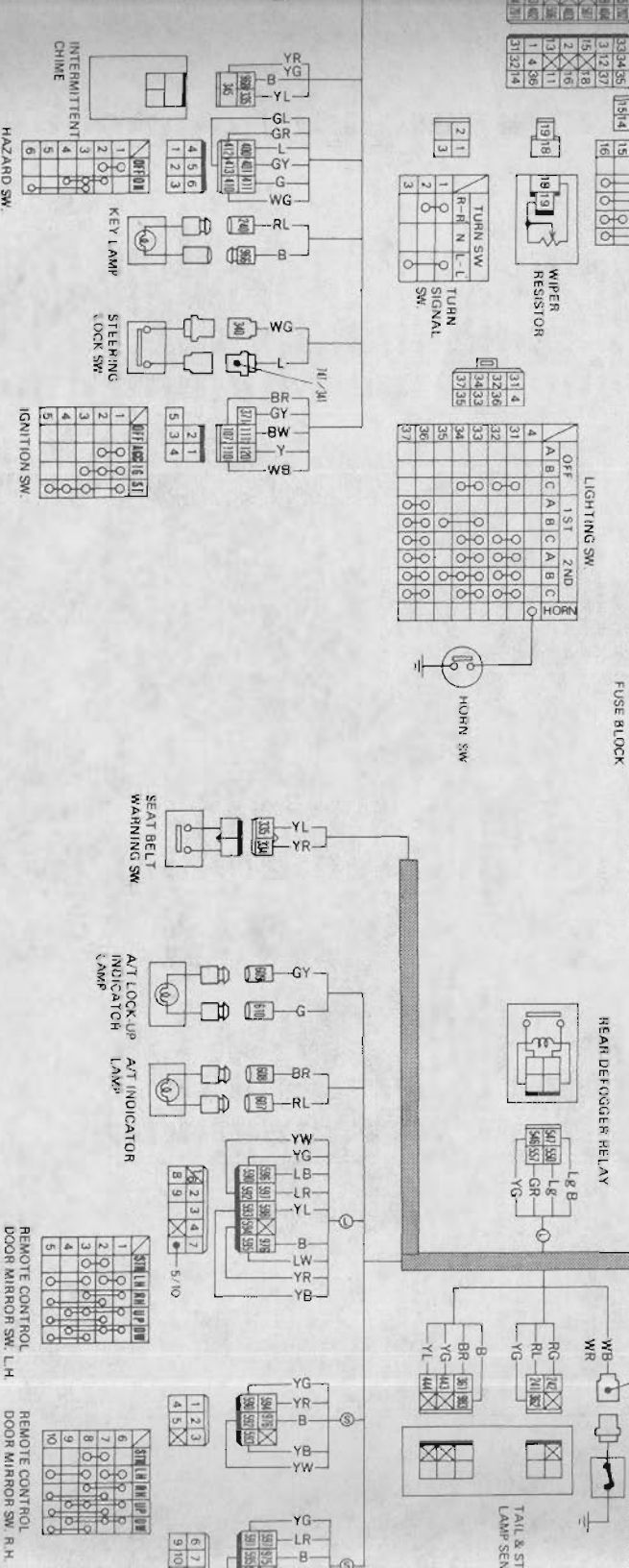
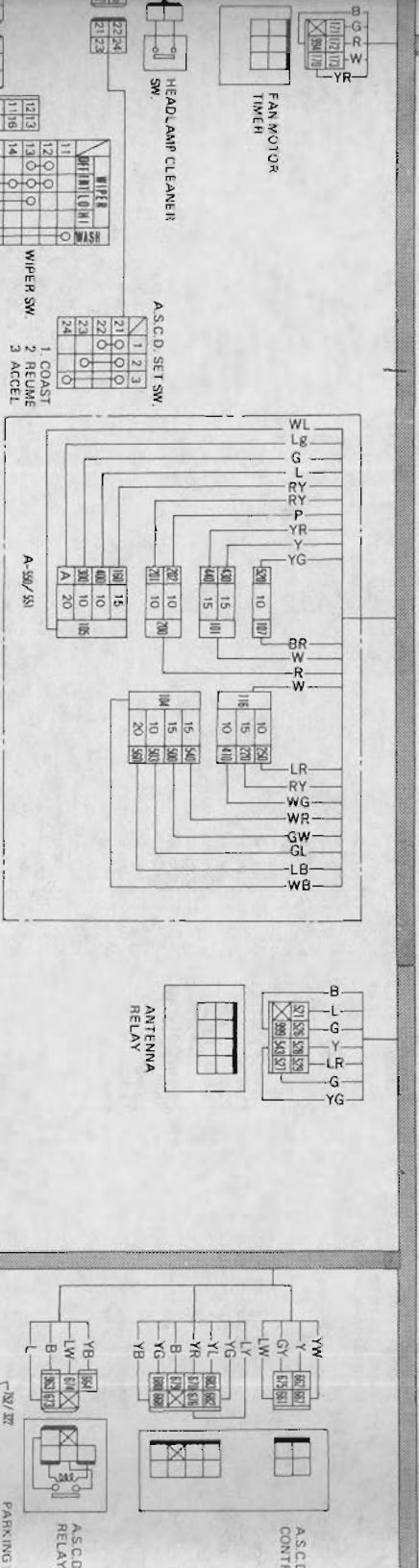
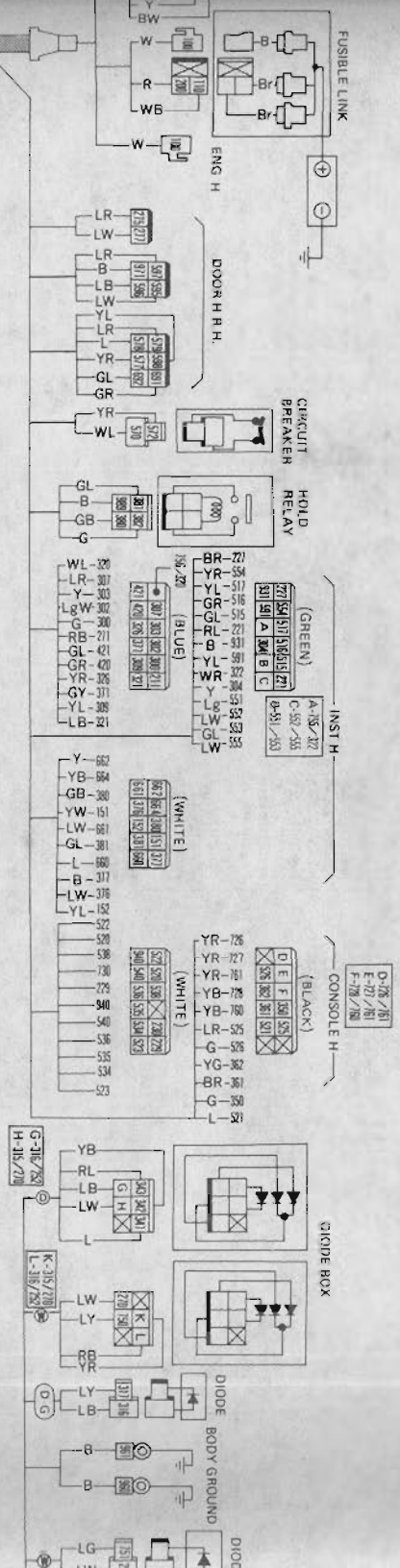

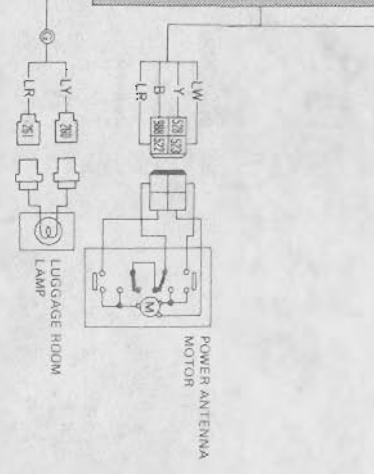
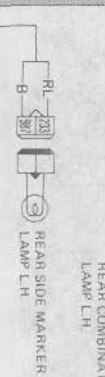
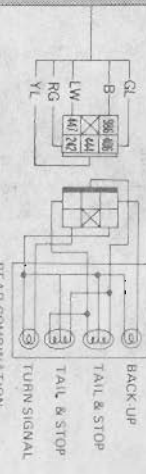
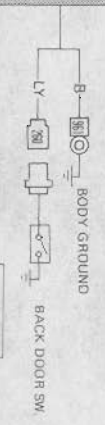
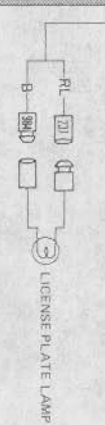
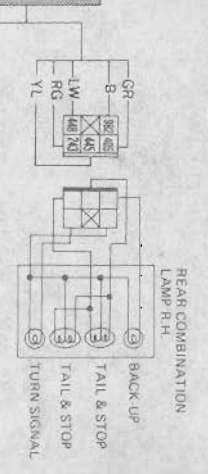
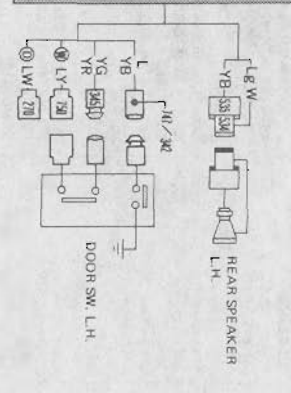
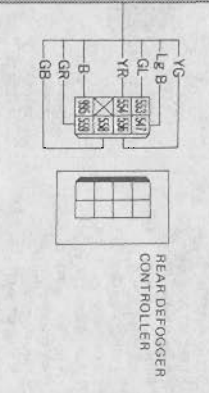
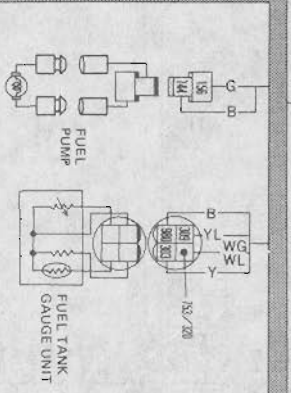
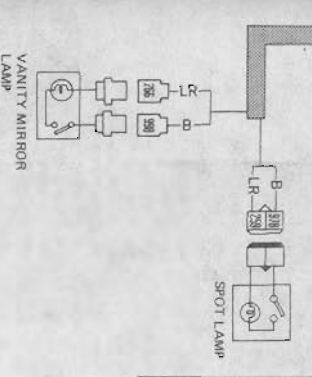
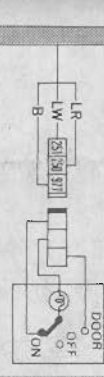
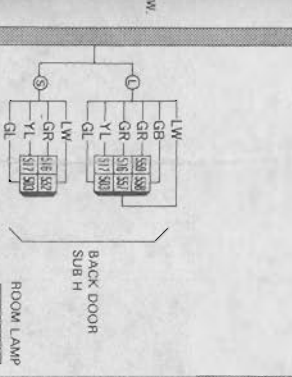
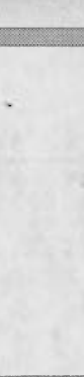
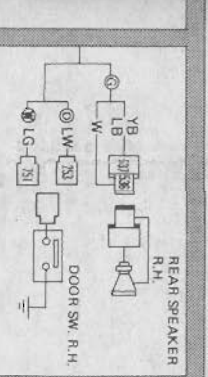
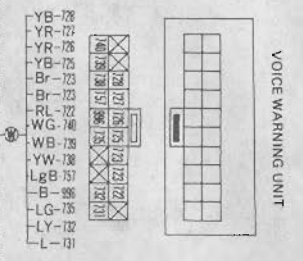
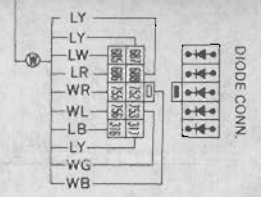

- 24019 P9900 [1] 24019 P9010 [6]
- 24019 P9900 [2] 24019 P9010 [7]
- 24019 P9901 [3] 24019 P9014 [8]
- 24019 P9963 [1] 24019 P9070 [5]
- 24019 P9963 [2] 24019 P9070 [6]
- 24019 P9073 [3] 24019 P9073 [4]

1983 DATSUN 280ZX MAIN HARNESS (NON-TURBO)

NO.	FROM	TO	REMARKS
ENGINE ELECTRICAL SYSTEM			
100	ENGINE ROOM H	F/BLINK	
101	100	F/BLCK	
102	866	ACC RELAY	
103	866	IGN RELAY	
104	F/BLCK	ACC RELAY	
105	F/BLCK	IGN RELAY	
107	IGN SW	F/BLCK	
108	141	IGN RELAY	
110	F/BLINK	IGN SW	
111	IGN SW	IGN SW	
112	HIC IGN DIS	HIC IGN DIS	
113	HIC IGN DIS	111	
114	107	ACC RELAY	
116	101	F/BLCK	
120	IGN SW	ENG ROOM H	
140	IGN COIL	ENG ROOM H	
141	110	FUEL PUMP RELAY	
142	120	EG1 H	
143	149	ENG ROOM H	
144	FUEL PUMP RELAY	FUEL PUMP SUB H	
145	144	EG1 H	
146	EG1 H	FUEL PUMP RELAY	
149	111	EG1 H	
160	ALTITUDE SW	EG1 H	
161	ALTITUDE SW	EG1 H	
170	440	INJ BLOWER TIMER	
171	300	INJ BLOWER TIMER	
172	300	INJ BLOWER TIMER	
173	WATER T SENSOR	INJ BLOWER TIMER	
LIGHTING SYSTEM			
200	F/BLINK	F/BLCK	
201	F/BLCK	COMB SW	
202	F/BLCK	COMB SW	
203	COMB SW	ENG ROOM H	
204	COMB SW	ENG ROOM H	
205	COMB SW	ENG ROOM H	
211	204	INST H	
220	F/BLCK	COMB SW	
221	233	INST H	
222	AIRCON H	INST H	
228	233	INST H	
229	CONSOLE H	ASHCON H	
230	233	221	
231	233	CONSOLE H	
233	COMB SW	ENG ROOM H	
234	233	SIDE W LAMP LH	
235	233	SIDE W LAMP RH	
236	233	RR COMB L RH	
237	233	RR COMB L RH	
240	233	LICENSIT LAMP	
241	233	KEY LAMP	
242	242	TAIL & STOP SENSOR	
243	242	RR COMB L RH	
250	F/BLCK	RR COMB L RH	
251	ROOM LAMP	ROOM LAMP	
252	ROOM LAMP TIMER	ROOM L TIMER	
253	ROOM LAMP TIMER	DIODE BOX	
253	279	DOOR SW RH	
253	270	DOOR SW RH	
255	273	DIODE	
258	290	STEP LAMP RH	
259	290	STEP LAMP RH	
261	250	STEP LAMP RH	
262	257	STEP LAMP RH	
263	280	STEP LAMP LH	
264	280	STEP LAMP LH	
265	273	STEP LAMP LH	
268	STEP LAMP	282	
269	STEP LAMP LH	251	
280	LUGGAGE ROOM	SPOT LAMP	
281	250	B/DOOR SW	
286	257	LUGGAGE ROOM L	
270	ROOM L TIMER	VAINYTY MIRROR	
271	273	DIODE BOX/DOOR SW LH	
272	DOOR H LH	DOOR H LH	
273	280	251	
274	ROOM L TIMER	ROOM L TIMER	
275	273	DOOR H LH	
275	280	DOOR H RH	
275	280	DOOR H RH	

NO.	FROM	TO	REMARKS
276	280	DOOR H RH	
277	280	DOOR H RH	
278	DOOR H LH	282	
279	DOOR H LH	DOOR SW LH	
280	290	STEP L RELAY	
281	STEP RELAY	279	
282	DOOR H RH	STEP L RELAY	
283	DOOR H LH	277	
METER, GAUGES AND WARNING SYSTEM			
300	F/BLCK	INST H	
302	RESISTOR	INST H	
303	INST H	TANK UNIT GAUGE	
304	INST H	WATER T SENSOR	
307	280	INST H	
307	273	INST H	
308	140	RESISTOR	
309	INST H	TANK UNIT GAUGE	
315	DIODE CONN	253	
316	DIODE BOX	DIODE	
317	DIODE CONN	DIODE CONN	
317	DIODE	260	
320	INST H	TANK UNIT GAUGE (S)	
321	INST H	316	
321	INST H	279	
321	INST H	252	
322	INST H	PARKING B SW	
326	334	INST H	
333	400	SEAT BELT TIMER	
334	234	SEAT BELT SW	
335	SEAT BELT SW	INT CHIME	
340	410	STRG LOCK SW	
341	STRG LOCK SW	DIODE BOX	
342	DIODE BOX	DOOR SW LH	
343	233	DIODE BOX	
345	DOOR SW LH	INT CHIME	
347	345	INST H	
350	300	CONSOLE H	
351	381	CONSOLE H	
352	382	CONSOLE H	
371	INST H	IGN SW	
380	INST H	HOLD RELAY	
381	INST H	HOLD RELAY	
382	392	HOLD RELAY	
390	300	SIGNAL SYSTEM	
400	F/BLCK	HAZARD SW	
401	HAZARD SW	T/SIGNAL F/UNIT	
402	T/SIGNAL F/UNIT	ENG ROOM H	
403	COMB SW	ENG ROOM H	
404	COMB SW	RR COMB L RH	
408	403	RR COMB L RH	
409	404	HAZARD SW	
410	F/BLCK	HAZARD SW	
411	HAZARD SW	403	
412	HAZARD SW	402	
413	HAZARD SW	400	
421	406	INST H	
430	F/BLCK	ENG ROOM H	
433	ENG ROOM H	COMB SW	
440	F/BLCK	STOP SW	
441	STOP SW	RR COMB L LH	
442	441	RR COMB L RH	
443	STOP SW	TAIL & STOP L SENSOR	
444	TAIL & STOP L SENSOR	RR COMB L LH	
445	444	RR COMB L RH	
446	444	RR COMB L RH	
447	ENG ROOM H	RR COMB L LH	
448	ENG ROOM H	RR COMB L RH	
447	447	RR COMB L LH	
447	447	RR COMB L RH	
ACCESSORY SYSTEM			
500	F/BLCK	WIPEP MOTOR	
501	500	WIPEP MOTOR	
502	500	WIPEP MOTOR	
503	F/BLCK	B/DOOR SUB H	
504	INT WIPEP AMP	WIPEP MOTOR	
505	INT WIPEP AMP	WIPEP MOTOR	
506	COMB SW	WIPEP MOTOR	
507	COMB SW	WIPEP MOTOR	
508	COMB SW	INT WIPEP AMP	
509	COMB SW	INT WIPEP AMP	

NO.	FROM	TO	REMARKS
510	COMB SW	INT WIPER AMP 506	
511	WASHER TANK	H/LAMP CLEANER SW	
512	501	H/LAMP CLEANER	
513	H/LAMP CLEANER SW	WASHER TANK	
514	WIPER MOTOR	INST H	
515	503	R/OOOR SUB H	
516	INST H	R/OOOR SUB H	
517	INST H	INT WIPER AMP	
519	COMB SW	INST H	
520	F/BLCK	CONSOL H	
521	ANTENNA RELAY	CONSOL H	
522	CONSOL H	MOTOR ANTENNA	
523	CONSOL H	MOTOR ANTENNA	
526	273	CONSOL H	
528	ANTENNA RELAY	CONSOL H	
527	ANTENNA RELAY	300	
528	ANTENNA RELAY	MOTOR ANTENNA	
529	ANTENNA RELAY	250	
534	CONSOL H	SPEAKER LH	
538	CONSOL H	SPEAKER RH	
536	CONSOL H	SPEAKER RH	
537	535	SPEAKER RH	
538	CONSOL H	CONDENSER	
539	111	CONSOL H	
540	F/BLCK	590	
543	ANTENNA RELAY	R/R DEF RELAY	
546	590	R/R DEF RELAY	
547	R/R DEF CONTROLLER	R/R DEF RELAY	
550	F/BLCK	R/R DEF RELAY	
551	F/BLCK	INST H	
552	INST H	R/OOOR SUB H	
553	R/R DEF CONTROLLER	INST H	
554	R/R DEF CONTROLLER	INST H	
555	557	INST H	
556	590	R/R DEF CONTROLLER	
557	R/R DEF RELAY	B/OOOR SUB H	
558	R/R DEF CONTROLLER	R/OOOR SUB H	
559	R/R DEF CONTROLLER	R/OOOR SUB H	
560	F/BLCK	AIRCON H	
561	AIRCON H	ENG ROOM H	
562	AIRCON H	ENG ROOM H	
563	560	ENG ROOM H	
568	101	AIRCON H	
569	AIRCON H	ENG ROOM H	
570	105	CIRCUIT BRAKER	
572	912	DOOR H LH	
577	912	DOOR H RH	
578	DOOR H LH	DOOR H RH	
579	DOOR H LH	DOOR H RH	
580	753	V/W UNIT	
581	753	V/W UNIT	
586	713	V/W UNIT	
590	520	REMOCON SW LH	
591	590	INST H	
591	598	R/O MIRROR SW RH	
592	REMOCON M SW LH	DOOR H LH	
593	REMOCON M SW LH	DOOR H LH	
594	REMOCON M SW LH	DOOR H LH	
595	REMOCON M SW RH	DOOR H RH	
596	REMOCON M SW RH	DOOR H RH	
597	REMOCON M SW RH	DOOR H RH	
598	REMOCON MIRROR SW	DOOR H RH	
599	598	DOOR H LH	
600	SUPPLEMENTAL NUMBER		
606	300	K O SW	
608	K O SW	ENG ROOM H	
607	233	TORCON IND LAMP	
608	TORCON IND LAMP	227	
610	ENG ROOM H	L U IND	
610	300	L U IND	
660	400	INST H	
661	INST H	ASCO CONTROLLER	
662	ASCO CONTROLLER	INST H	
663	662	ENG ROOM H	
664	ASCO RELAY	INST H	
667	INST H	ASCO CONTROLLER	
668	COMB SW	ASCO CONTROLLER	
669	COMB SW	G/D	
670	STOP SW	ASCO CONTROLLER	

NO.	FROM	TO	REMARKS
671	CLUTCH SW	STOP SW	
672	661	CL RH SW	
673	400	ASCO RELAY	
674	ASCO RELAY	661	
675	ASCO CONTROLLER	ENG ROOM H	
676	ASCO CONTROLLER	ENG ROOM H	
677	671	ENG ROOM H	
679	ASCO CONTROLLER	983	
680	448	ASCO CONTROLLER	
682	COMB SW	ASCO CONTROLLER	
683	COMB SW	ASCO CONTROLLER	
690	430	DOOR L TIMER	
691	DOOR H RH	DOOR L TIMER	
692	DOOR H RH	DOOR L TIMER	
693	DOOR H LH	DOOR L TIMER	
694	DOOR H LH	DOOR L TIMER	
700	SUPPLEMENTAL NUMBER		
702	485	INST H	
722	223	V/W UNIT	
723	V/W UNIT	V/W UNIT	
726	535	V/W UNIT	
726	CONSOL H	V/W UNIT	
727	V/W UNIT	CONSOL H	
728	V/W UNIT	CONSOL H	
731	673	V/W UNIT	
732	790	V/W UNIT	
735	751	V/W UNIT	
738	667	V/W UNIT	
739	752	V/W UNIT	
740	753	V/W UNIT	
742	ENG ROOM H	DIODE CONN	
743	DIODE CONN	DIODE CONN	
745	ENG ROOM H	DIODE BOX	
746	DIODE BOX	INST H	
747	STG LOCK SW	DOOR SW LH	
748	794	DIODE BOX	
751	DIODE BOX	DOOR SW LH	
752	DIODE CONN	DOOR SW RH	
753	DIODE CONN	PARKING B SW	
754	DOOR SW LH	TANK UNIT GAUGE	
755	DOOR SW LH	INT CHIME	
756	INST H	DIODE CONN	
757	INST H	DIODE CONN	
760	V/W UNIT	ENG ROOM H	
815	V/W UNIT	ENG ROOM H	
815	CONSOL H	CONSOL H	
900	GROUND		
931	INST H	ENG ROOM H	
940	CONSOL H	931	
950	DOOR L TIMER	973	
951	ROOM L TIMER	980	
962	STEP L RELAY	983	
963	STEP L RELAY	983	
960	BODY GROUND	931	
961	BODY GROUND	931	
962	AIRCON H	BODY GROUND	
963	ASCO RELAY	931	
964	WIPER MOTOR	993	
965	COMB SW	995	
966	KEY LAMP	931	
967	T/SIGNAL F/UNIT	965	
968	INT CHIME	985	
969	INT WIPER AMP	985	
970	SEAT BELT TIMER	982	
971	DOOR H RR (R/GM)	931	
972	DOOR H LH (P/W)	985	
975	REMOCON M SW RH	976	
976	REMOCON M SW LH	983	
977	ROOM LAMP	961	
978	SPOT LAMP	977/998	
979	FUEL PUMP SUB H	961	
980	HOLD RELAY	961	
980	TANK UNIT GAUGE	961	
981	SIDE M LAMP RH	961	
982	RR COMB L RH	961	
983	TAIL & STOP L SENSOR	961	
984	LICENSE LAMP	982	
985	IGN RELAY	982	
986	RR COMB L LH	962	
987	SIDE M LAMP LH	956	
988	MOTOR ANTENNA	961	
990	ASCO RELAY	962	
991	FUEL PUMP RELAY	462	
993	H/LAMP CLEANER	964	
994	INU BLOWER TIMER	931	
995	RR DEF CONTROLLER	961	
996	V/W UNIT	961	
998	VANITY MIRROR L	977	
999	ANTENNA RELAY	960	

NO.	FROM	TO	REMARKS
999	ANTENNA RELAY	960	

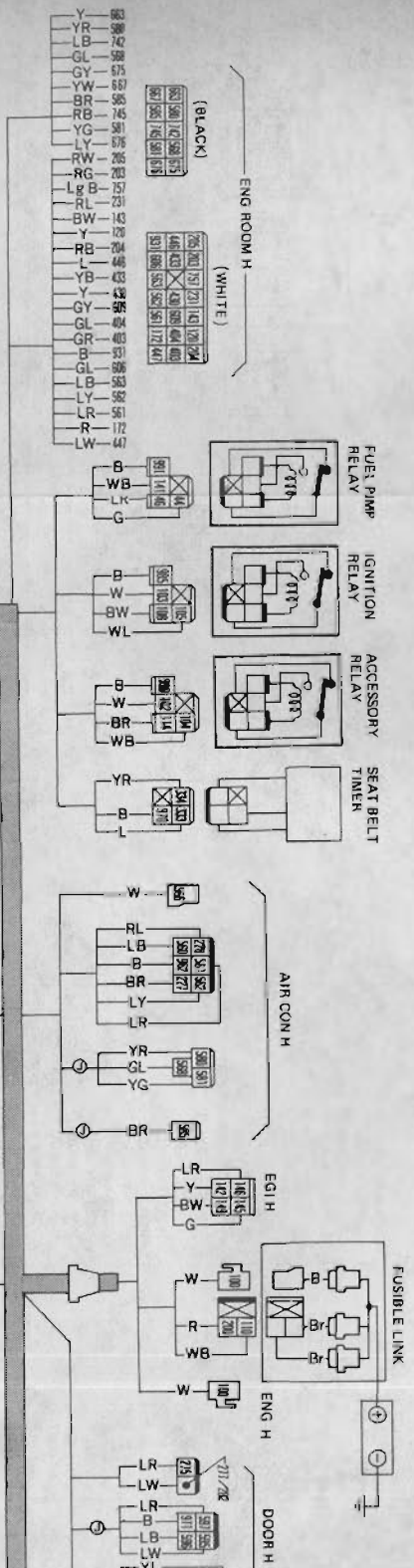
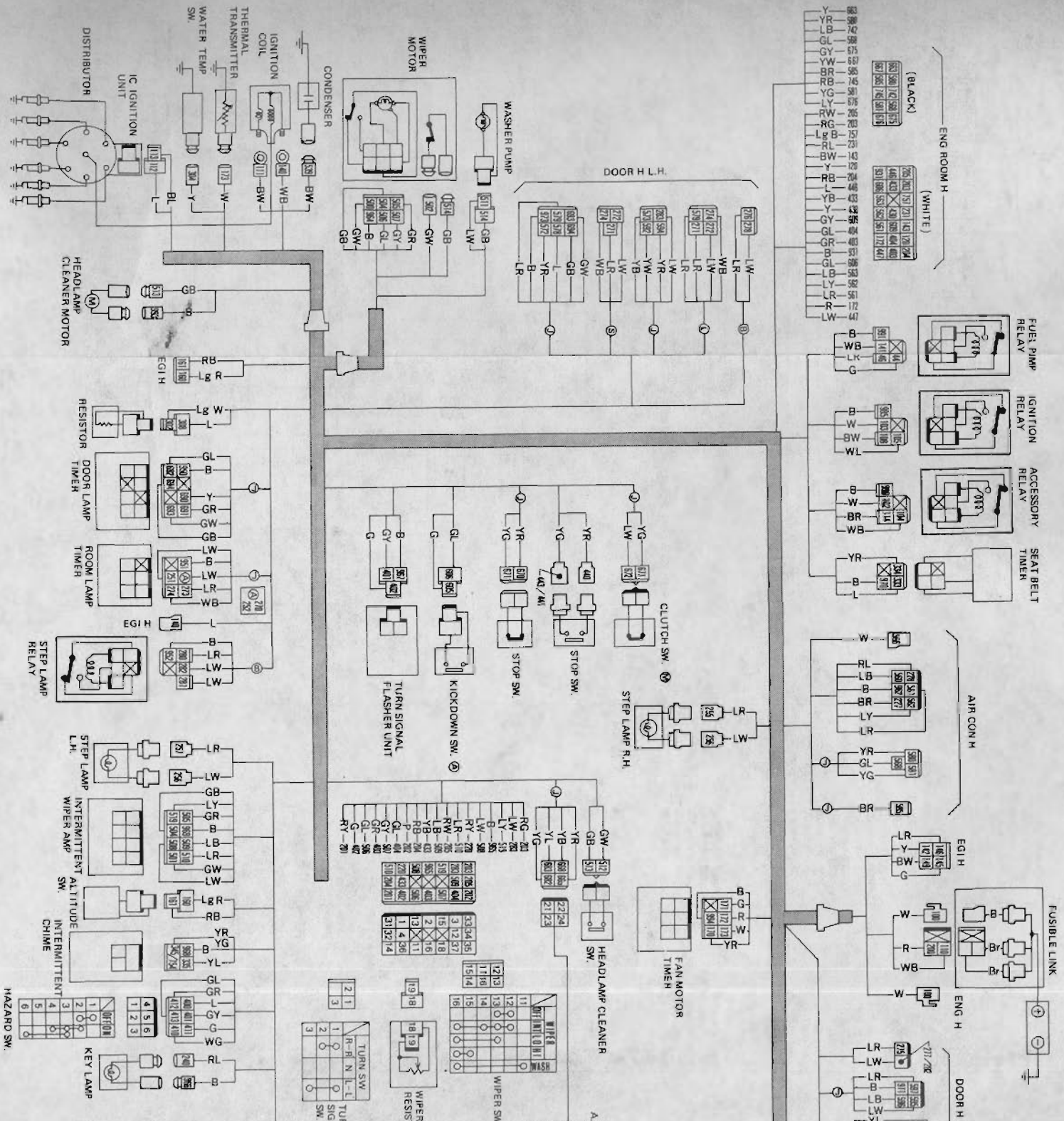

WIPER SW.

11	12	13	14	15	16
11	12	13	14	15	16
11	12	13	14	15	16
11	12	13	14	15	16

WIPER RESIST.

18	19
18	19
18	19
18	19

TURN SW.

1	2	3
1	2	3
1	2	3
1	2	3

TURN SIGNAL SW.

1	2	3	4	5	6
1	2	3	4	5	6
1	2	3	4	5	6
1	2	3	4	5	6

KEY LAMP

1	2	3	4	5	6
1	2	3	4	5	6
1	2	3	4	5	6
1	2	3	4	5	6

HAZARD SW.

1	2	3	4	5	6
1	2	3	4	5	6
1	2	3	4	5	6
1	2	3	4	5	6

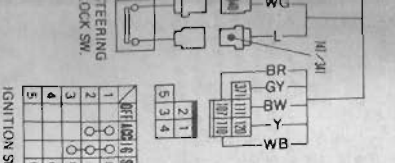
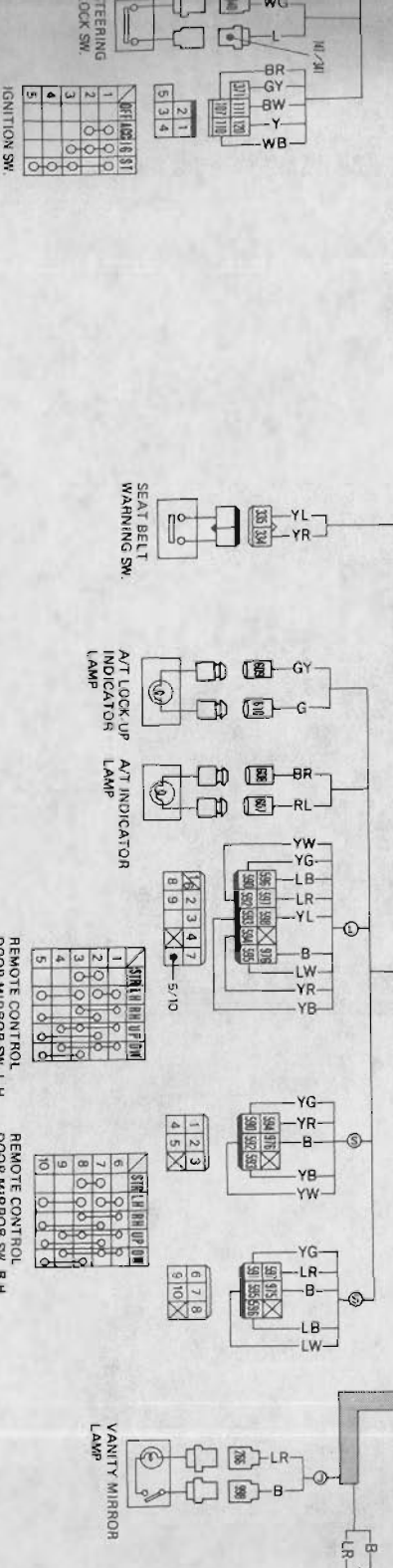
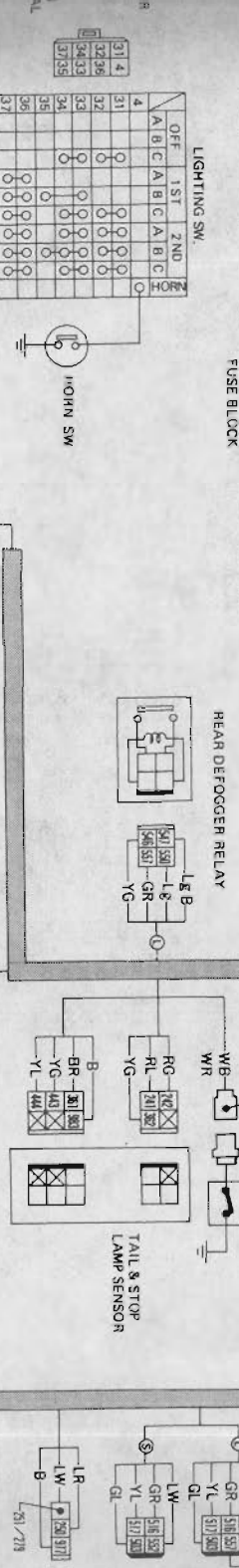
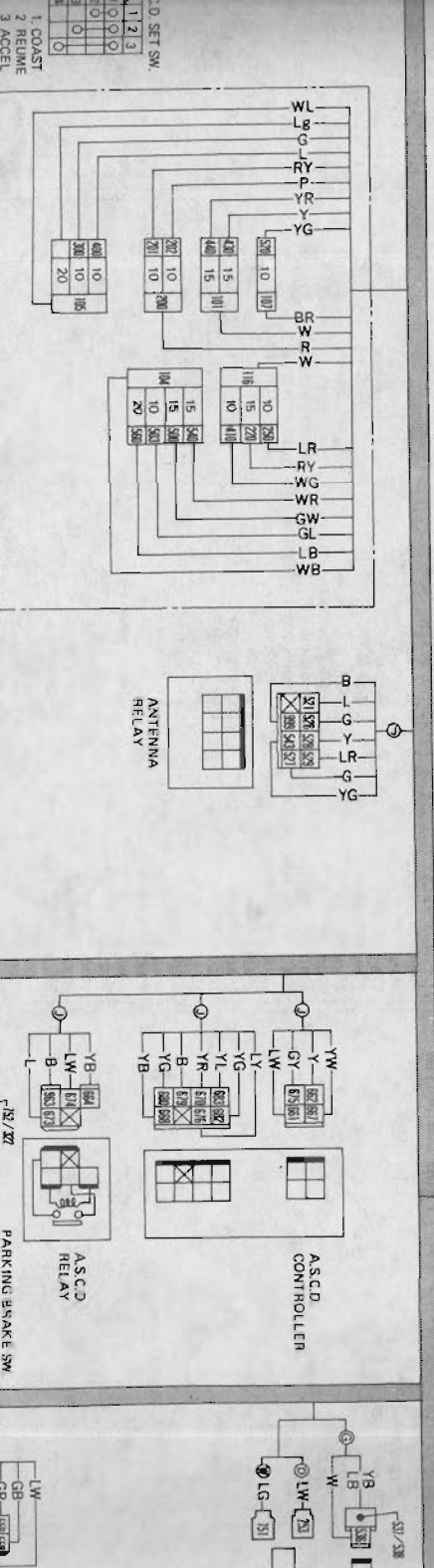
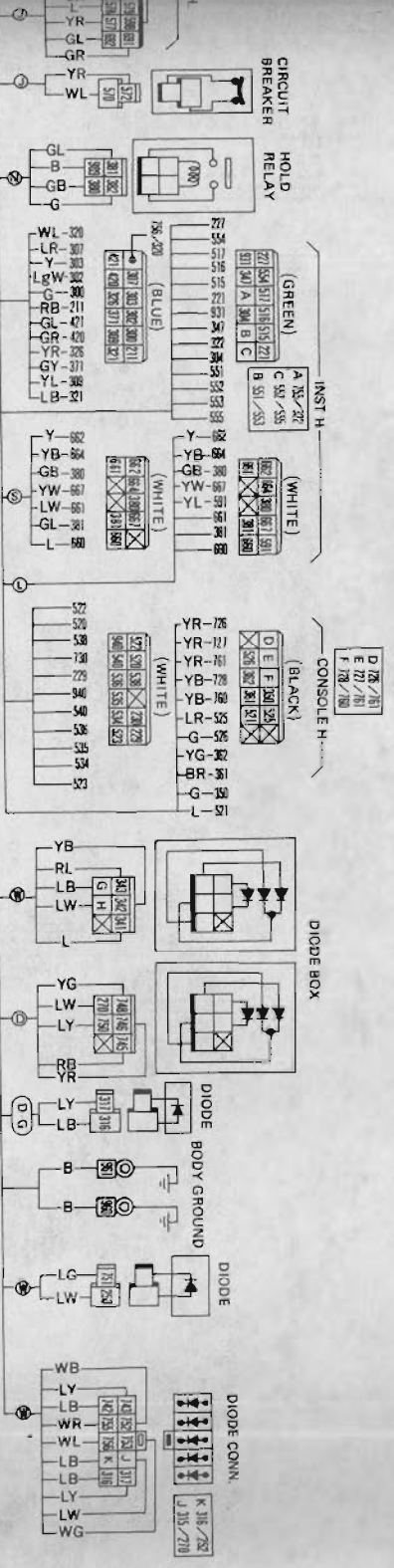

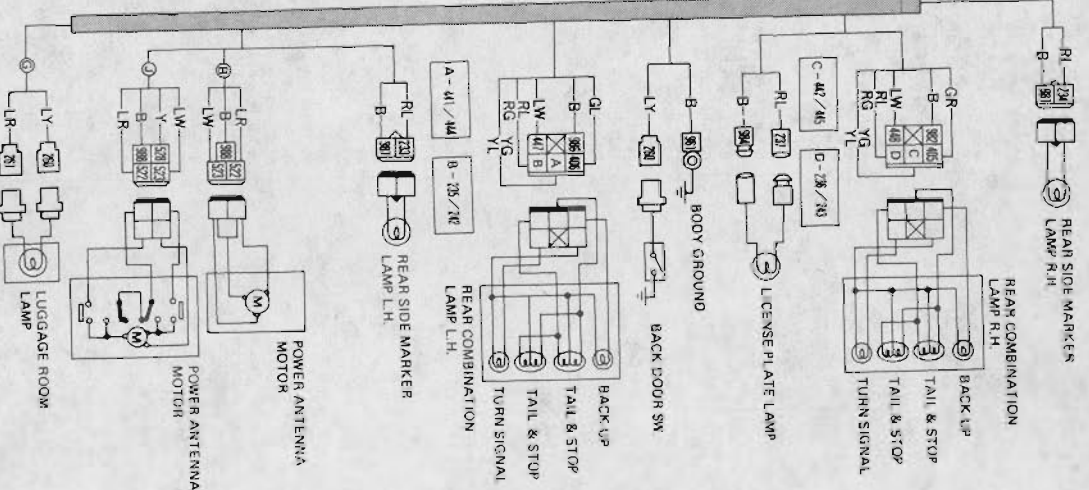
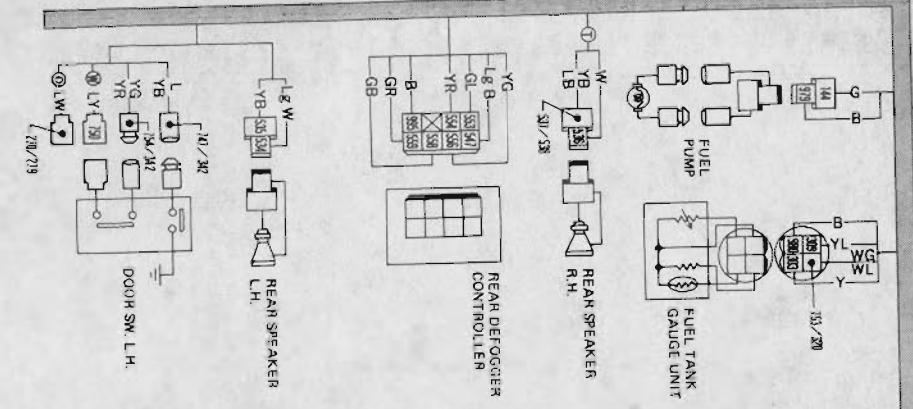
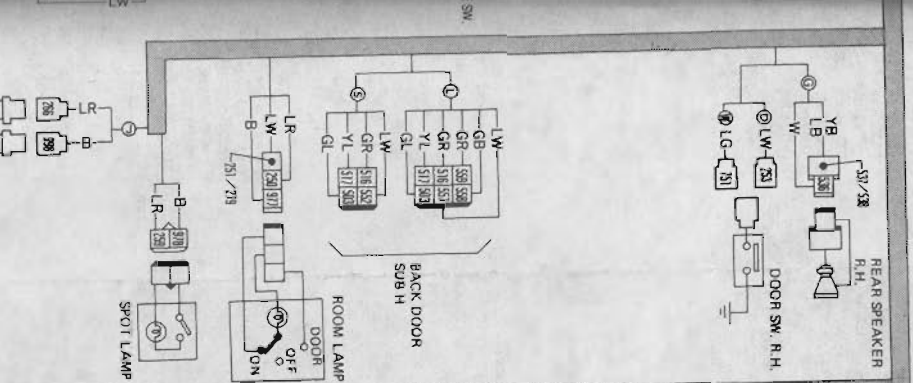
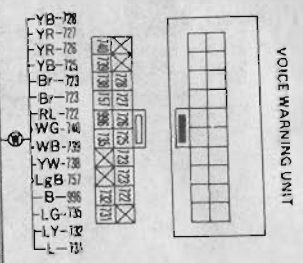
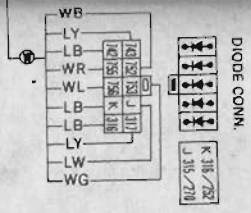

24019 P9700 []
 24019 P9701 []
 24019 P9702 []
 24019 P9703 []

1983 DATSUN 280ZX CONSOLE HARNNESS

NO.	FROM	TO	REMARKS
200	LIGHTING SYSTEM		
229	MAIN H	RADIO	
230	MAIN H	RADIO	
269	230	RADIO	GL MODEL
300	METER, GAUGES AND WARNING SYSTEM		
350	MAIN H	DISP AMP	
352	ENG ROOM H	DISP AMP	
353	ENG ROOM H	DISP AMP	
354	230	DISP AMP	
360	ENG ROOM H	DISP AMP	
361	MAIN H	DISP AMP	
362	MAIN H	DISP AMP	
500	ACCESSORY SYSTEM		
520	MAIN H	DECK	
521	ANT SW	520	EXCEPT GL MODEL
521	ANT SW	MAIN H	GL MODEL
522	ANT SW	MAIN H	
523	ANT SW	MAIN H	
524	RADIO	520	GL MODEL
525	RADIO	MAIN H	
526	RADIO	MAIN H	
530	RADIO	MAIN H	
531	MAIN H	INST H	
532	RADIO	INST H	
534	RADIO	MAIN H	
535	RADIO	MAIN H	
536	RADIO	MAIN H	
538	542	MAIN H	GL MODEL
540	MAIN H	CIG LIGHTER	
541	230	CIG LIGHTER	
542	RADIO	INST H	GL MODEL
544	MAIN H	INST H	GL MODEL
900	GROUND		
940	CIG LIGHTER	MAIN H	
944	DISP AMP	940	

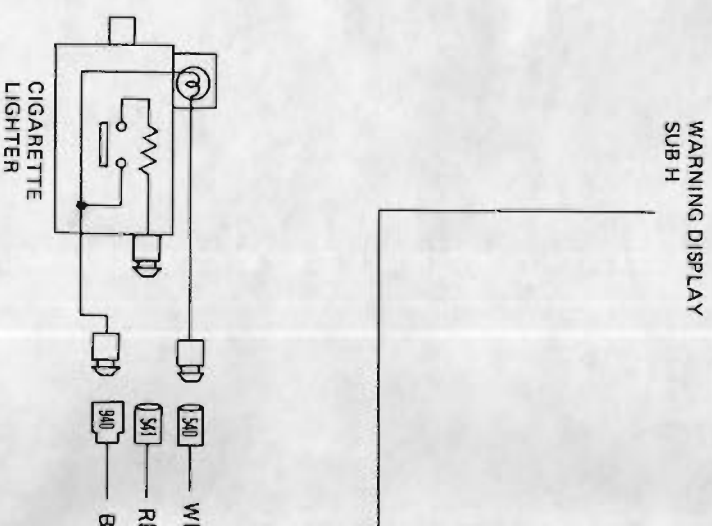

- Ⓐ GL MODELS
- Ⓑ EXCEPT GL MODELS
- Ⓒ WARNING DISPLAY

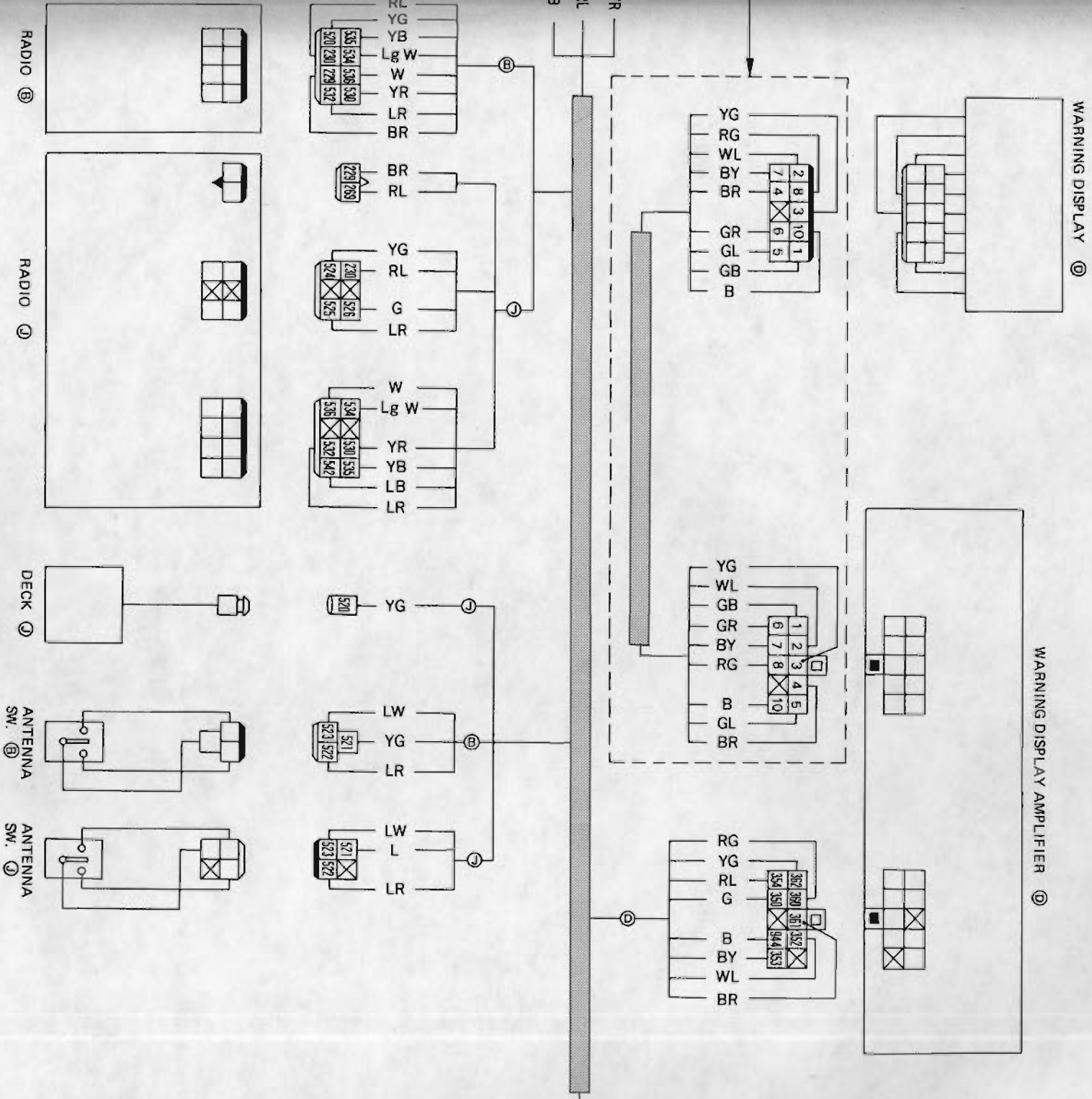

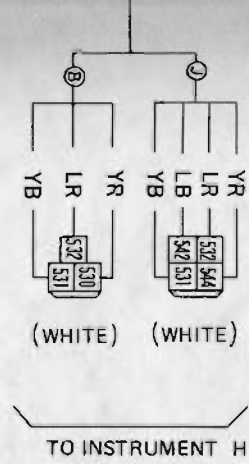
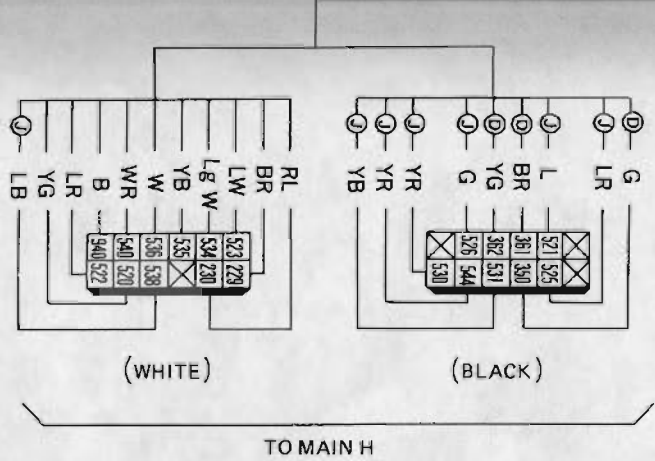
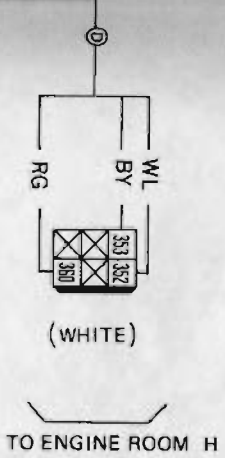

- 24023 P9100 2
- 24023 P9100
- 24023 P9101 3
- 24023 P9103
- 24023 P9104

1983 DATSUN 280ZX INSTRUMENT HARNESS

NO.	FROM	TO	REMARKS
100	ENGINE ELECTRICAL SYSTEM		
190	ENG ROOM H	GAUGE	NON-TURBOCHARGER MODELS
191	ENG ROOM H	METER	TURBOCHARGER MODELS
200	LIGHTING SYSTEM		
210	ENG ROOM H	METER	
211	MAIN H	METER	MODELS EQUIPPED WITH DIGITAL METERS
221	223	METER	MODELS EQUIPPED WITH ANALOG METERS
221	MAIN H	METER	MODELS EQUIPPED WITH ANALOG METERS
222	221	GAUGE	MODELS EQUIPPED WITH DIGITAL METERS
222	223	GAUGE	MODELS EQUIPPED WITH DIGITAL METERS
223	ILL UNIT	221	MODELS EQUIPPED WITH ANALOG METERS
223	ILL UNIT	MAIN H	MODELS EQUIPPED WITH DIGITAL METERS
224	ILL UNIT	METER	
225	224	GAUGE	
226	METER	223	MODELS EQUIPPED WITH DIGITAL METERS
227	225	MAIN H	
228	METER	224	MODELS EQUIPPED WITH DIGITAL METERS
244	223	CONSOLE LAMP	MODELS EQUIPPED WITH DIGITAL METERS
244	221	CONSOLE LAMP	MODELS EQUIPPED WITH ANALOG METERS
262	223	GLOVE BOX LAMP	MODELS EQUIPPED WITH DIGITAL METERS
262	221	GLOVE BOX LAMP	MODELS EQUIPPED WITH ANALOG METERS
300	METER, GAUGES AND WARNING SYSTEM		
300	MAIN H	METER	
301	300	GAUGE	
302	MAIN H	METER	
303	MAIN H	METER	
304	MAIN H	METER	
305	ENG ROOM H	GAUGE	TURBOCHARGER MODELS
306	ENG ROOM H	GAUGE	
307	MAIN H	METER	
309	MAIN H	METER	
310	METER	300	MODELS EQUIPPED WITH DIGITAL METERS
320	MAIN H	METER	
321	MAIN H	METER	
322	MAIN H	METER	
323	ENG ROOM H	322	
324	ENG ROOM H	METER	
326	MAIN H	METER	
336	ENG ROOM H	GAUGE	
347	MAIN H	METER	
370	METER	DIODE	
371	DIODE	MAIN H	
372	MAIN H	CUT-OFF CONNECTOR	
373	METER	CUT-OFF CONNECTOR	
376	MAIN H	BOOST METER	
377	MAIN H	939	
380	METER	MAIN H	
381	MAIN H	DIODE	
400	SIGNAL SYSTEM		
420	MAIN H	METER	
421	MAIN H	METER	
500	ACCESSORY SYSTEM		
515	RR WIPER SW	MAIN H	
516	RR WIPER SW	MAIN H	
517	RR WIPER SW	MAIN H	
518	RR WIPER H	ENG ROOM H	
530	SPEAKER (LH)	CONSOLE H	
531	SPEAKER (LH)	CONSOLE H	
532	SPEAKER (RH)	CONSOLE H	
533	SPEAKER (RH)	531	
542	SPEAKER (RH)	CONSOLE H	
545	515	GAUGE	
546	METER	515	
548	223	RR DEF SW	MODELS EQUIPPED WITH DIGITAL METERS
549	224	RR DEF SW	
551	RR DEF SW	MAIN H	MANUAL DEF
552	RR DEF SW	MAIN H	MANUAL DEF
553	RR DEF SW	MAIN H	AUTO DEF
554	RR DEF SW	MAIN H	AUTO DEF
555	RR DEF SW	MAIN H	AUTO DEF
591	METER	MAIN H	MODELS EQUIPPED WITH DIGITAL METERS
592	METER	MAIN H	MODELS EQUIPPED WITH DIGITAL METERS
600	SUPPLEMENTAL NUMBER		
660	ASC D SW	MAIN H	GL MODEL
661	ASC D SW	MAIN H	GL MODEL
662	ASC D SW	MAIN H	GL MODEL
664	ASC D SW	ASC D SW	GL MODEL
665	ASC D SW	223	GL MODEL
666	ASC D SW	225	GL MODEL

NO.	FROM	TO
667	METER	MAIN H
672	METER	MAIN H
678	METER	ENG ROOM H
681	METER	933
900	GROUND	
930	ILL UNIT	ENG ROOM H
931	930	MAIN H
932	930	RR DEF SW
933	930	METER
934	930	ASC D SW
935	930	GAUGE
936	METER	933
937	930	GLOVE BOX L
938	930	CONSOLE H
939	930	BOOST METER

REMARKS

MODELS EQUIPPED WITH DIGITAL METERS

COMBINATION METER/DIGITAL METER

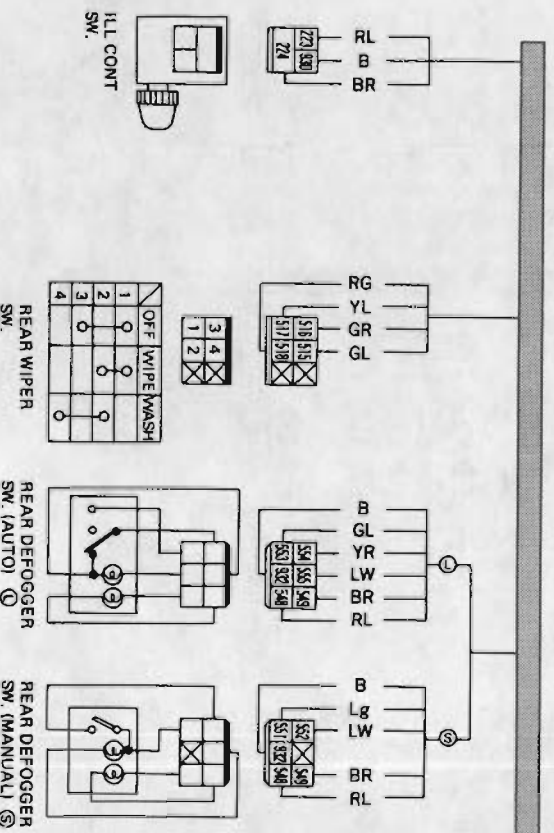
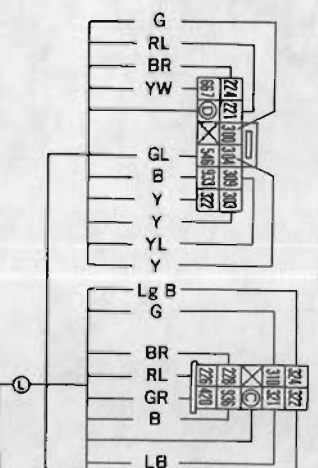
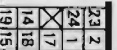
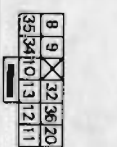
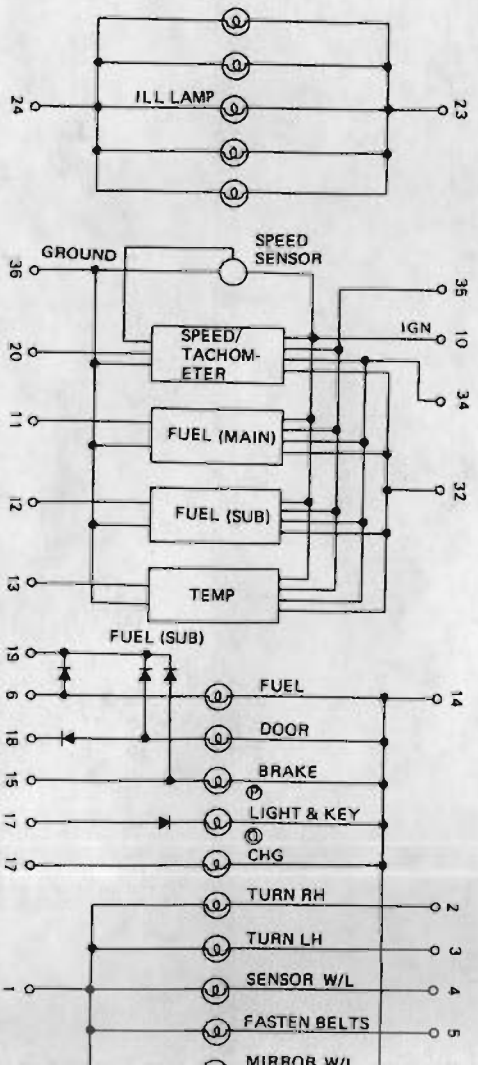

COMBINATION METER/EXCEPT DIGITAL METER

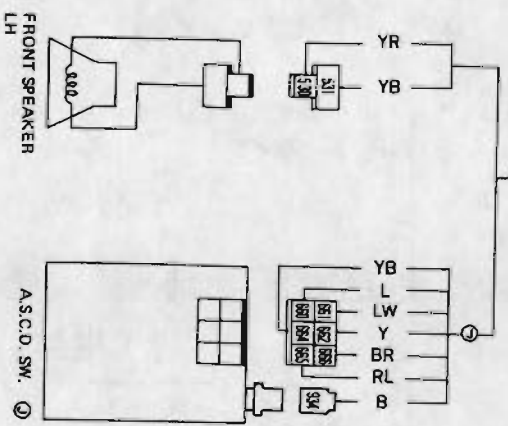
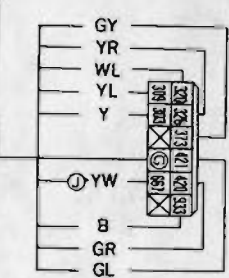
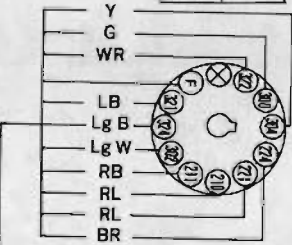
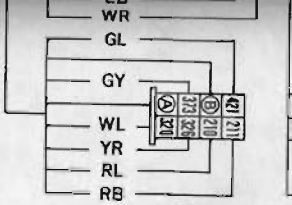
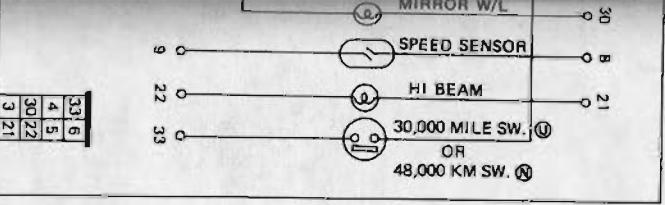
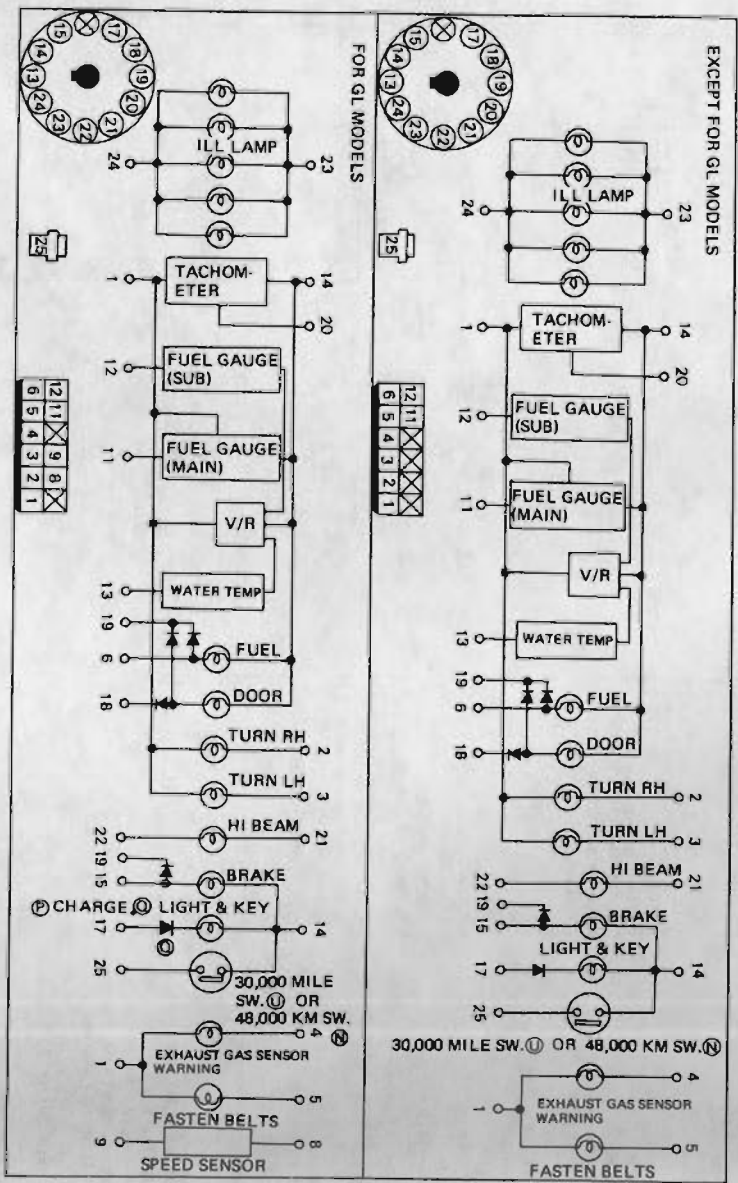

- ① GL MODELS
- ② EXCEPT GL MODELS
- ③ U.S.A. MODELS
- ④ CANADA MODELS
- ⑤ TURBOCHARGER MODELS
- ⑥ NON-TURBOCHARGER MODELS
- ⑦ TURBOCHARGER WITH DIGITAL METER MODELS
- ⑧ NON-TURBOCHARGER WITH DIGITAL METER MODELS
- ⑨ DIGITAL METER MODELS
- ⑩ EXCEPT DIGITAL METER MODELS

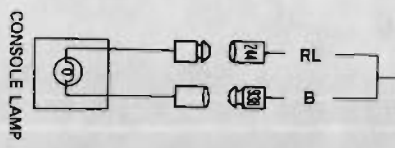

GLOW

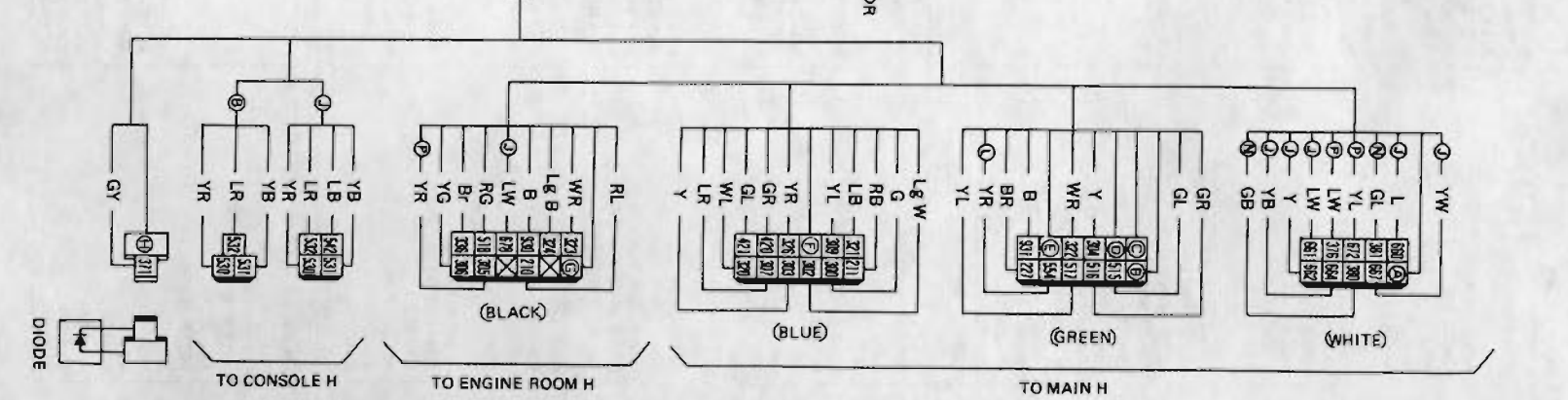
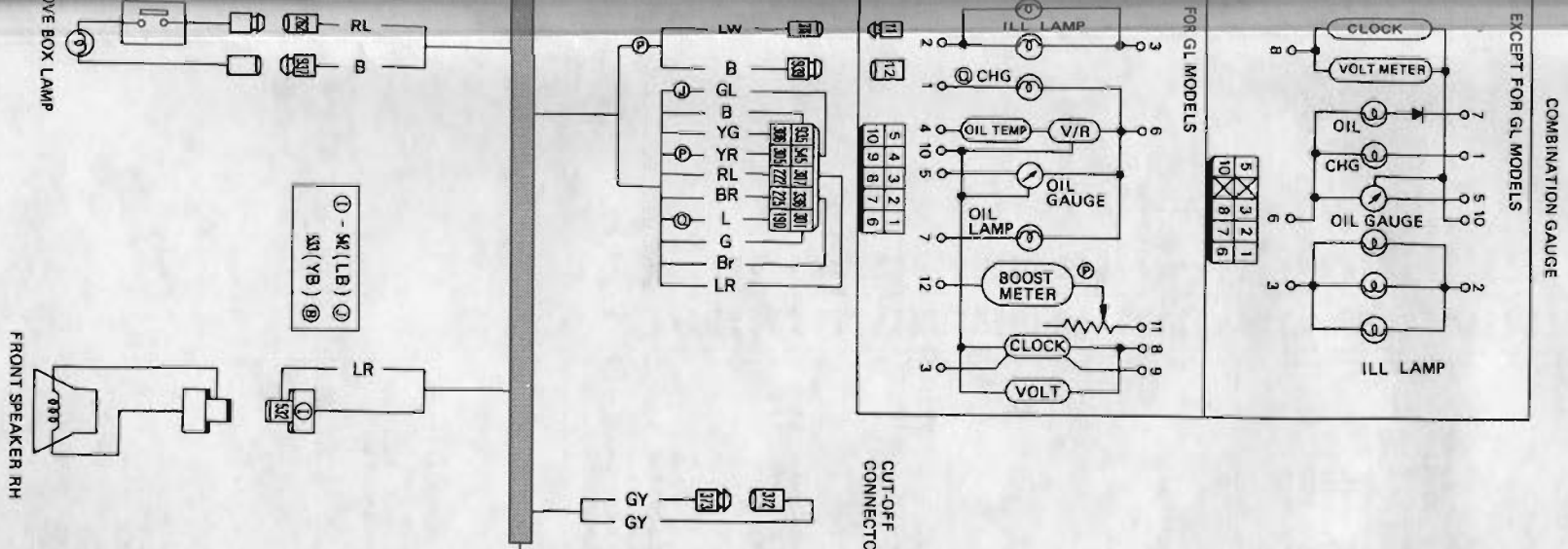

Ⓐ - 317 (B) Ⓜ Ⓢ
32 (YL) Ⓜ Ⓢ

Ⓓ - 221 (RL) Ⓢ
23 (RL) Ⓢ
Ⓒ - 51 (LG) Ⓢ
33 (GL) Ⓢ
Ⓓ - 52 (LW) Ⓢ
33 (LW) Ⓢ
Ⓔ - 347 (YR) Ⓜ Ⓢ
31 (YL) Ⓜ Ⓢ

Ⓕ - 311 (GY)
312 (GY)

Ⓖ - 311 (L) Ⓢ
191 (L) Ⓢ

Ⓕ - 310 (GB) Ⓢ
311 (GL) Ⓢ

- 24013 P9100 ⑤
- 24013 P9100
- 24013 P9101
- 24013 P9101
- 24013 P9010
- 24013 P9200
- 24013 P9201
- 24013 P9210
- 24013 P9700 ⑤
- 24013 P9700
- 24013 P9800
- 24013 P9701
- 24013 P9901

1983 DATSUN 280ZX ENGINE ROOM HARNESS

NO.	FROM	TO	REMARKS
ENGINE ELECTRICAL SYSTEM			
100	ALTERNATOR	MAIN H	
109	ALTERNATOR	100	
120	MAIN H	ST MOTOR	M/T
121	MAIN H	INHIB RELAY	A/T GL
122	INHIB SW	ST MOTOR	A/T EXCEPT GL
122	INHIB RELAY	INHIB SW	A/T EXCEPT GL
123	MAIN H	INHIB RELAY	A/T GL
143	MAIN H	ENG SUB H	TURBOCHARGER M/T
153	MAIN H	ENG SUB H	TURBOCHARGER A/T
154	MAIN H	601	TURBOCHARGER M/T
160	FAN MOTOR RELAY	MAIN H	TURBOCHARGER A/T
161	FAN MOTOR RELAY	FAN MOTOR	TURBOCHARGER
162	DIODE	564	TURBOCHARGER
163	FAN MOTOR RELAY	DIODE	TURBOCHARGER
164	FAN MOTOR RELAY	MAIN H	TURBOCHARGER
165	FAN MOTOR RELAY	DIODE	TURBOCHARGER
166	FAN MOTOR RELAY	DIODE	TURBOCHARGER
172	MAIN H	AUXILIARY COOLING FAN MOTOR	TURBOCHARGER
190	ALTERNATOR	INST H	
LIGHTING SYSTEM			
200	MAIN H	DIMMER RELAY	USA EXCEPT GL
203	MAIN H	HEAD LAMP LH	USA EXCEPT GL
204	MAIN H	HEAD LAMP RH	
205	MAIN H	HEAD LAMP LH	
206	DIMMER RELAY	HEAD LAMP LH	
207	206	HEAD LAMP RH	
208	DIMMER RELAY	HEAD LAMP LH	
209	208	HEAD LAMP RH	
210	208	INST H	
231	MAIN H	FR SIDE MARKER LAMP LH	
232	231	FR SIDE MARKER LAMP RH	
238	231	FR COMBINATION LAMP RH	
239	231	FR COMBINATION LAMP LH	
254	430	INSPECTION L	
METER, GAUGES AND WARNING SYSTEM			
300	INST H	OIL TEMPERATURE SENSOR	TURBOCHARGER
305	INST H	OIL PRESSURE SENDING UNIT	
306	INST H	BRAKE FLUID LEVEL SW	
323	INST H	757	GL
324	INST H	BULB CHECK RELAY	EXCEPT GL
336	OIL P SENDING U	INST H	
345	BULB CHECK RELAY	446	NON-TURBOCHARGER M/T
346	BULB CHECK RELAY	449	NON-TURBOCHARGER A/T
347	BULB CHECK RELAY	160	TURBOCHARGER
348	BULB CHECK RELAY	190	
352	COOLANT LEVEL SENSOR	CONSOLE H	USA GL & CANADA
353	WASHER LEVEL SW	CONSOLE H	USA GL & CANADA
360	HEAD LAMP SENSOR	CONSOLE H	USA GL & CANADA
366	HEAD LAMP RH	HEAD LAMP SENSOR	USA GL & CANADA
367	MAIN H	HEAD LAMP SENSOR	USA GL & CANADA
368	HEAD LAMP LH	HEAD LAMP SENSOR	USA GL & CANADA
369	MAIN H	HEAD LAMP SENSOR	USA GL & CANADA
SIGNAL SYSTEM			
400	MAIN H	FR COMBINATION LAMP RH	
403	MAIN H	FR COMBINATION LAMP LH	
404	MAIN H	HORN RELAY	
430	MAIN H	HORN RELAY	
431	HORN LH	HORN RELAY	
432	HORN RH	431	
433	MAIN H	HORN RELAY	NON-TURBOCHARGER M/T
446	MAIN H	REVERSE SW	TURBOCHARGER M/T
446	MAIN H	ENG SUB H	NON-TURBOCHARGER M/T
447	MAIN H	REVERSE SW	NON-TURBOCHARGER M/T
447	MAIN H	ENG SUB H	NON-TURBOCHARGER M/T
449	MAIN H	INHIB SW	A/T
450	MAIN H	INHIB SW	A/T
ACCESSORY SYSTEM			
500	INST H	FR WASHER MOTOR	
518	INST H	100	
538	CONDENSER	SOLENOID VALVE	
561	MAIN H	A/C RELAY	
562	MAIN H	A/C RELAY	
563	MAIN H	A/C RELAY	
564	A/C RELAY	SOLENOID VALVE	
565	COMPRESSOR	564	AUTO A/C
567	563	HEATER SW	AUTO A/C
568	MAIN H	HEATER SW	TURBOCHARGER
569	564	MAIN H	AUTO A/C
580	MAIN H	AMB SW	AUTO A/C
581	MAIN H	AMB SW	AUTO A/C
582	LOW PRESSURE SW	AMB SW	AUTO A/C

NO.	FROM	TO
584	A/C RELAY	LOW PRESSURE SW
585	A/C RELAY	MAIN H
SUPPLEMENTAL NUMBER		
600	INHIB RELAY	INHIB SW
601	MAIN H	ENG SUB H
606	MAIN H	ENG SUB H
609	449	VAC PUMP RELAY
659	446	VAC PUMP RELAY
659	446	RELEASE VALVE
663	MAIN H	SERVO VALVE
675	MAIN H	SERVO VALVE
676	MAIN H	SERVO VALVE
677	MAIN H	INHIB RELAY
678	INST H	INHIB RELAY
684	VAC PUMP RELAY	VAC PUMP
688	MAIN H	VAC PUMP RELAY
689	MAIN H	VAC SW
SUPPLEMENTAL NUMBER		
700	231	LIGHT RELAY
741	LIGHT RELAY	MAIN H
742	LIGHT RELAY	LIGHT RELAY
744	741	MAIN H
745	LIGHT RELAY	BULB CHECK RELAY
757	MAIN H	
GROUND		
900	ALTERNATOR	BODY EARTH
900	ENG EARTH	900
902	FR SM LAMP	907
903	907	FR COMBINATION LAMP LH
904	903	DIMMER RELAY
905	905	DIMMER RELAY
906	905	FR COMBINATION LAMP RH
907	907	FR SIDE MARKER LAMP RH
908	907	FR SIDE MARKER LAMP RH
909	VAC PUMP	913 905
910	905	BULB CHECK RELAY
911	903 905 907 908 920	AMB SW
912	905	SOLENOID VALVE
913	912	LOW PRESSURE SW
914	919	BRAKE FLUID LEVEL SW
915	905	VACUUM SW
916	919	WASHER LEVEL SW
917	900 921	WASHER LEVEL SW
918	905	COOLANT LEVEL SENSOR
919	903	RR WASHER MOTOR
920	907	FAN MOTOR
921	900	INHIB SW
922	905	HEAD LAMP SENSOR
923	900	RELEASE VALVE
924	900	AUXILIARY COOLING FAN
930	931	INST H
931	900	MAIN H

REMARKS
AUTO A/C
A/T GL
A/T NON-TURBOCHARGER A/T
GL TURBOCHARGER A/T
GL TURBOCHARGER M/T
GL A/T GL
GL A/T GL
GL TURBOCHARGER
GL TURBOCHARGER
GL TURBOCHARGER
GL NON-TURBOCHARGER GL
GL NON-TURBOCHARGER GL
GL NON-TURBOCHARGER GL
GL NON-TURBOCHARGER GL
GL
910
AUTO A/C
MANUAL A/C
TURBOCHARGER
USA GL & CANADA
A/T
USA GL & CANADA
TURBOCHARGER
A/T GL
USA GL & CANADA
GL
MOTOR

